

## OPTOTRONIC Cable Clamp



### Vlastnosti produktu

- Snadno instalovatelné a flexibilní odlehčení tahu
- Samostatná odlehčení tahu pro primární a sekundární stranu
- Přednasazené pojistné šrouby
- Prosmýčkování (verze TL)

### Výhody produktu

- Snadné a rychlé ukotvení kabelu
- Dostatek prostoru pro připojení kabelů
- Cenově výhodné řešení a šetří místo (verze TL)
- Volné připojení kabelu díky otevřeným klapkám
- Okamžitá instalace díky předpřipraveným kabelovým svorkám

### Druh použití

- Podhledy, plochá svítidla
- Vhodné pro různé typy kabelů
- Vhodné pro vnitřní instalace

## Technický list řady výrobků

### Technické údaje

Popis výrobku	Rozměry & váha				Logistická data
	Váha výrobku	Délka	Šířka	Výška	Zkratka produktu
OT CABLE CLAMP N-STYLE	20,00 g	37,0 mm	33,0 mm	23,0 mm	392690979000
OT CABLE CLAMP A-STYLE	29,00 g	35,0 mm	65,0 mm	25,0 mm	392690979000
OT CABLE CLAMP B-STYLE	26,00 g	49,2 mm	57,7 mm	29,5 mm	392690979000
OT CABLE CLAMP D-STYLE	28,60 g	38,5 mm	33,0 mm	29,5 mm	392690979000
OT CABLE CLAMP E-STYLE	16,00 g	38,0 mm	53,0 mm	25,0 mm	392690979000
OT CABLE CLAMP F-STYLE	16,00 g	38,0 mm	53,0 mm	30,0 mm	392690979000
OT CABLE CLAMP A-STYLE TL	80,00 g	90,0 mm	92,0 mm	25,0 mm	853690100000
OT CABLE CLAMP B-STYLE TL	80,00 g	90,0 mm	92,0 mm	29,5 mm	853690100000
OT CABLE CLAMP B-STYLE LP TL	35,00 g	50,0 mm	67,0 mm	22,0 mm	392690979000

Popis výrobku	Environmental information Information according Art. 33 of EU Regulation (EC) 1907/2006 (REACH)			
	Date of Declaration	Primary Article Identifier	Candidate List Substance 1	Declaration No. in SCIP database
OT CABLE CLAMP N-STYLE	12-02-2022	4062172046732   4052899598461	No declarable substances contained	In work
OT CABLE CLAMP A-STYLE	13-02-2022	4052899089570   4050732499425	No declarable substances contained	No declarable substances contained
OT CABLE CLAMP B-STYLE	13-02-2022	4052899077881	No declarable substances contained	No declarable substances contained
OT CABLE CLAMP D-STYLE	13-02-2022	4052899077904	No declarable substances contained	No declarable substances contained
OT CABLE CLAMP E-STYLE	13-02-2022	4052899167896	No declarable substances contained	No declarable substances contained
OT CABLE CLAMP F-STYLE	12-02-2022	4052899325555	No declarable substances contained	No declarable substances contained
OT CABLE CLAMP A-STYLE TL	12-02-2022	4052899325982	No declarable substances contained	No declarable substances contained
OT CABLE CLAMP B-STYLE TL	12-02-2022	4052899948051	No declarable substances contained	No declarable substances contained
OT CABLE CLAMP B-STYLE LP TL	12-02-2022	4052899530997	No declarable substances contained	No declarable substances contained

## Technický list řady výrobků

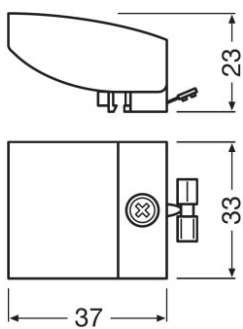

OT Cable clamp N-style

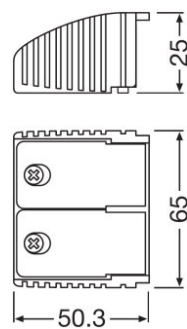

554789\_OT CABLE CLAMP A-STYLE

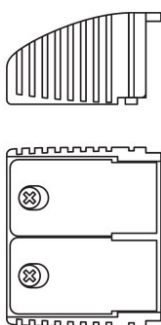

554796\_OT CABLE CLAMP A-STYLE

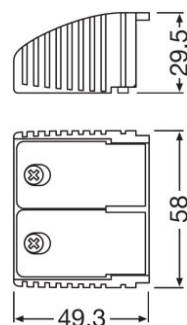

554790\_OT CABLE CLAMP B-STYLE

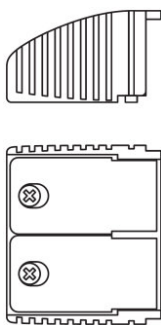

554797\_OT CABLE CLAMP B-STYLE

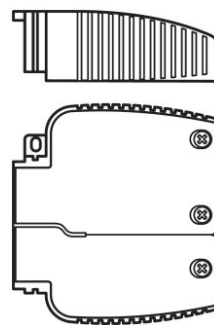

616419\_OT CABLE CLAMP B-STYLE

## Technický list řady výrobků

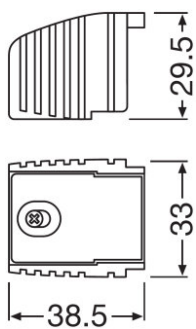

590902\_OT CABLE CLAMP D-STYLE

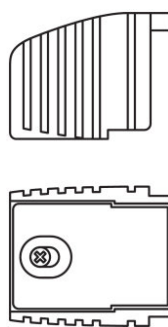

590906\_OT CABLE CLAMP D-STYLE

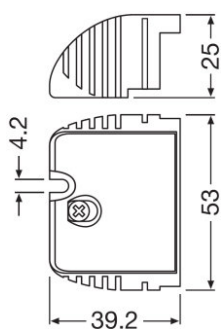

554791\_OT CABLE CLAMP E-STYLE

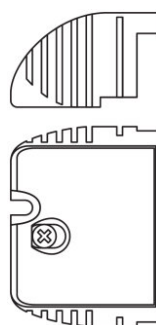

554798\_OT CABLE CLAMP E-STYLE

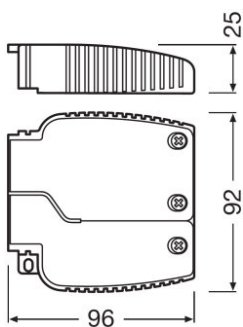

611986\_OT CABLE CLAMP A-STYLE TL

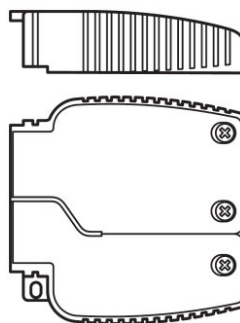

611988\_OT CABLE CLAMP A-STYLE TL

## Technický list řady výrobků

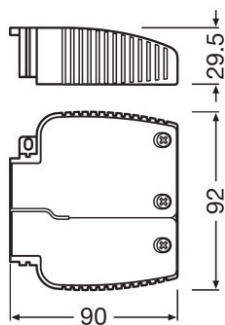

596667\_OT Cable Clamp B-Style TL

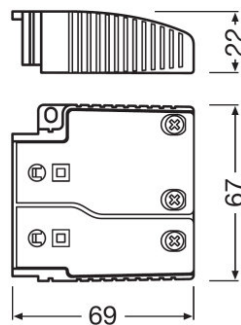

OT CABLE CLAMP B-STYLE LP







### Pokyny k použití

Podrobnější informace k použití a grafiku najdete v technickém listu.

### Technická podpora a podpora prodeje

Technická podpora a podpora prodeje [www.osram.cz](http://www.osram.cz)

### Stahování dat

Soubor	
	User instruction CABLE CLAMP N-STYLE
	CAD data OT Cable Clamp N Style IGS 61119
	CAD data 3-dim OT Cable Clamp N Style STEP 61119
	CAD data PDF OT Cable Clamp N Style CADPDF 61119
	CAD data CAD data IGS OT Cable Clamp A-Style
	CAD data CAD data STEP OT Cable Clamp A-Style
	CAD data PDF CAD data PDF OT Cable Clamp A-Style
	CAD data CAD data IGS OT Cable Clamp B-Style
	CAD data CAD data STEP OT Cable Clamp B-Style

## Technický list řady výrobků

	CAD data PDF CAD data PDF OT Cable Clamp B-Style
	CAD data CAD Data D-Style-Cable Clamp
	CAD data CAD Data D-Style-CableClamp STEP
	CAD data PDF CAD Data D-Style-CableClamp PDF
	CAD data CAD data IGS OT Cable Clamp E-Style
	CAD data CAD data STEP OT Cable Clamp E-Style
	CAD data PDF CAD data PDF OT Cable Clamp E-Style
	CAD data 673587_OT Cable Clamp F Style IGS 61119
	CAD data 673588_OT Cable Clamp F Style STEP 61119
	CAD data PDF 673589_OT Cable Clamp F Style CADPDF 61119
	User instruction OT CABLE CLAMP A STYLE TL
	CAD data CAD data IGS OT Cable Clamp A-Style TL
	CAD data CAD data STEP OT Cable Clamp A-Style TL
	CAD data PDF CAD data PDF OT Cable Clamp A-Style TL
	User instruction OT CABLE CLAMP B STYLE TL
	Addon Technical Information 592682_Cable Clamp B-Sytle Driver Assembly
	Installation/Operation notice 547465_OT Cable Clamp TL-B Instructions sheet
	CAD data CAD data IGS OT Cable Clamp B-Style TL
	CAD data CAD data STEP OT Cable Clamp B-Style TL
	CAD data 3-dim 592683_Cable Clamp B-Sytle STEP
	CAD data 3-dim 592684_Cable Clamp B-Sytle IGS
	CAD data PDF CAD data PDF OT Cable Clamp B-Style TL
	User instruction OT CABLE CLAMP B-STYLE LP

## Technický list řady výrobků



CAD data  
CAD data IGS OT Cable Clamp B-Style LP



CAD data  
CAD data STEP OT Cable Clamp B-Style LP



CAD data PDF  
CAD data PDF OT Cable Clamp B-Style LP

### Logistické údaje

Kód výrobku	Popis výrobku	Jednotka balení (kusy/jednotku)	Rozměry (délka x šířka x výška)	Objem	Hrubá hmotnost
4062172046732	OT CABLE CLAMP N-STYLE	Shipping carton box 100	380 mm x 297 mm x 208 mm	23.47 dm <sup>3</sup>	2571.00 g
4052899089570	OT CABLE CLAMP A-STYLE	Shipping carton box 20	336 mm x 110 mm x 68 mm	2.51 dm <sup>3</sup>	672.00 g
4052899077881	OT CABLE CLAMP B-STYLE	Shipping carton box 20	300 mm x 107 mm x 76 mm	2.44 dm <sup>3</sup>	605.00 g
4052899077904	OT CABLE CLAMP D-STYLE	Shipping carton box 40	178 mm x 84 mm x 141 mm	2.11 dm <sup>3</sup>	1216.00 g
4052899167896	OT CABLE CLAMP E-STYLE	Shipping carton box 20	275 mm x 85 mm x 64 mm	1.50 dm <sup>3</sup>	380.00 g
4052899325555	OT CABLE CLAMP F-STYLE	Shipping carton box 20	278 mm x 87 mm x 70 mm	1.69 dm <sup>3</sup>	383.00 g
4052899325982	OT CABLE CLAMP A-STYLE TL	Shipping carton box 20	470 mm x 188 mm x 68 mm	6.01 dm <sup>3</sup>	1788.00 g
4052899948051	OT CABLE CLAMP B-STYLE TL	Shipping carton box 20	470 mm x 188 mm x 68 mm	6.01 dm <sup>3</sup>	1788.00 g
4052899530997	OT CABLE CLAMP B-STYLE LP TL	Shipping carton box 20	256 mm x 146 mm x 82 mm	3.06 dm <sup>3</sup>	777.00 g

Zmíněný produktový kód udává nejmenší jednotku množství, kterou lze objednat. Jednotka balení může obsahovat jeden nebo více samostatných produktů. Při objednávání zadávejte jednotky balení nebo násobky jednotek balení.

### Vyloučení odpovědnosti

Změny bez předchozího upozornění vyhrazeny. Chyby a opomenutí vyhrazeny. Vždy se ujistěte, že používáte nejnovější vydání.